

SlideBar

891, 892, 893

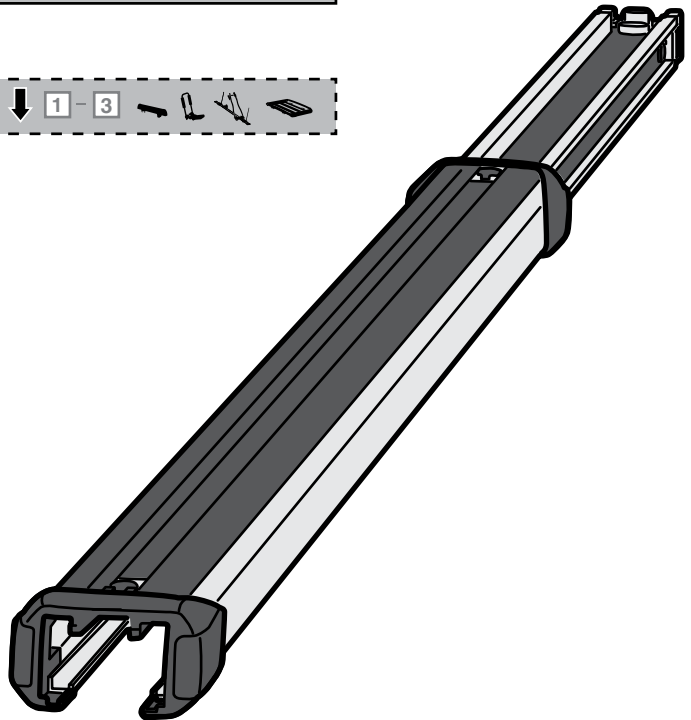

891000
892000
893000



ISO 11154-E

THULE[®]
SWEDEN

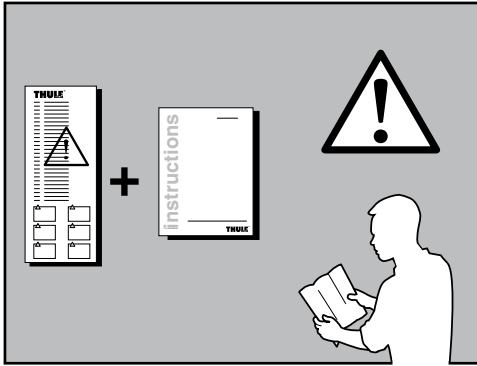

891	8,4 kg	18,5 lbs
892	9,4 kg	20,7 lbs
893	10,6 kg	23,4 lbs

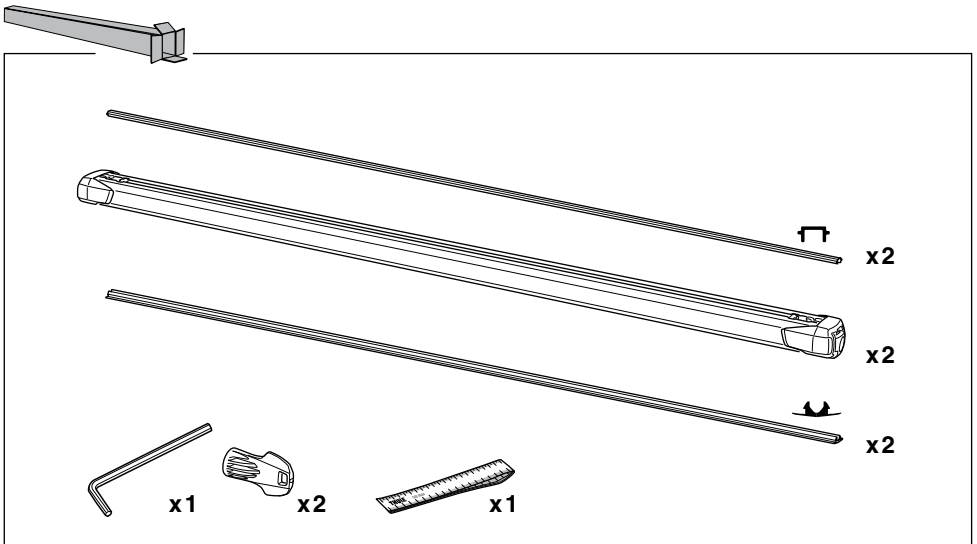
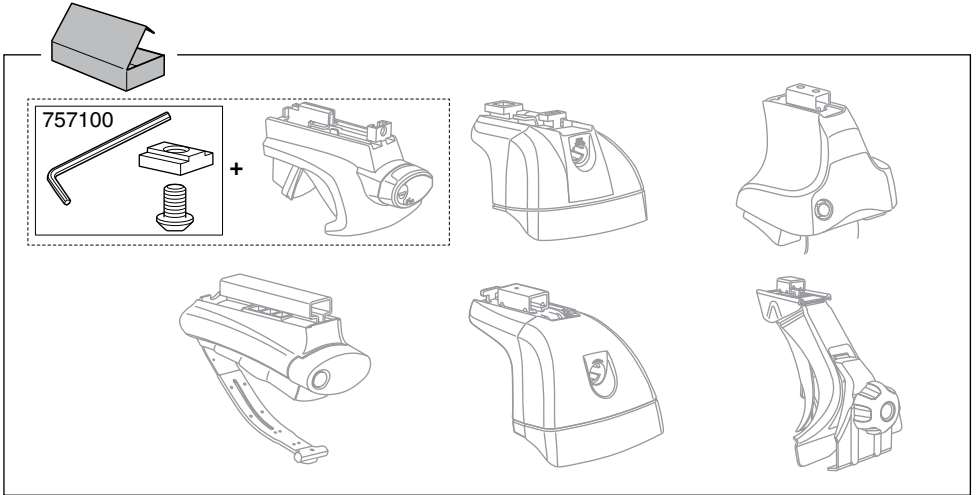



1

5



1

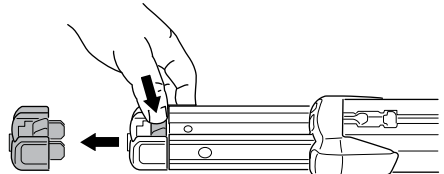
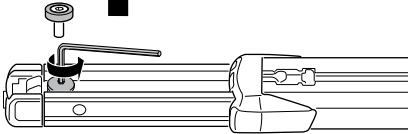
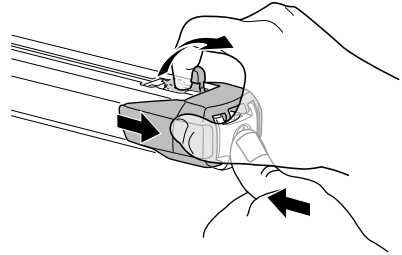
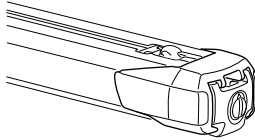
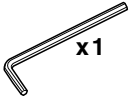

2

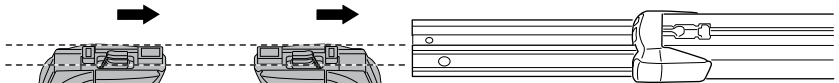
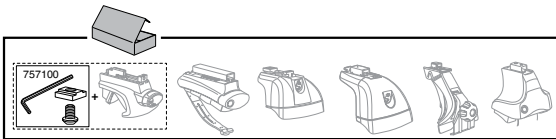

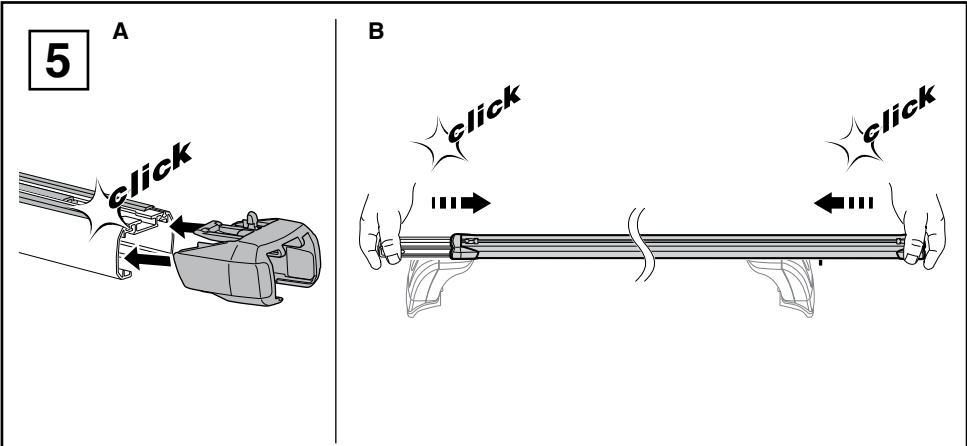
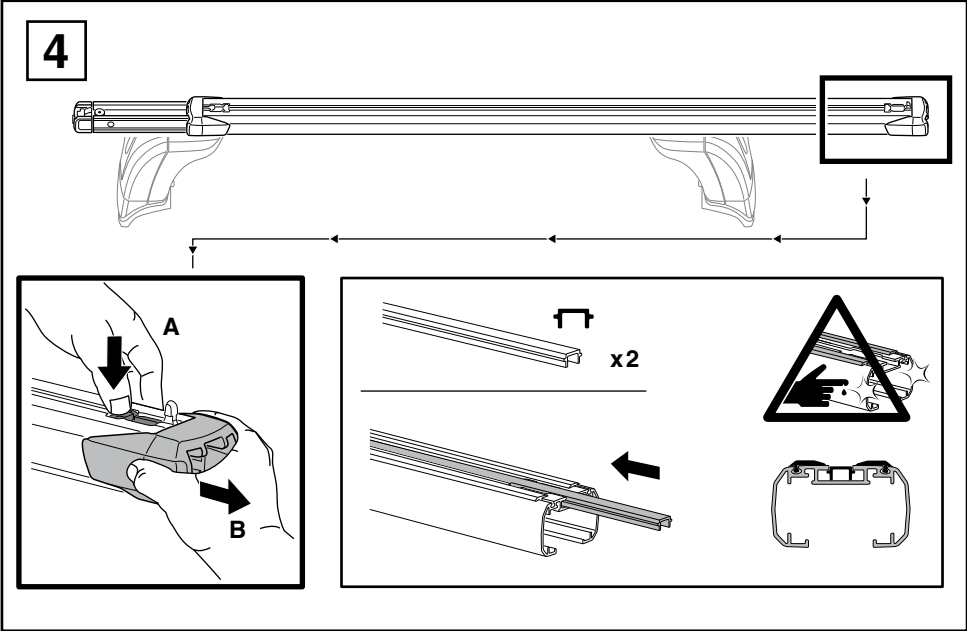
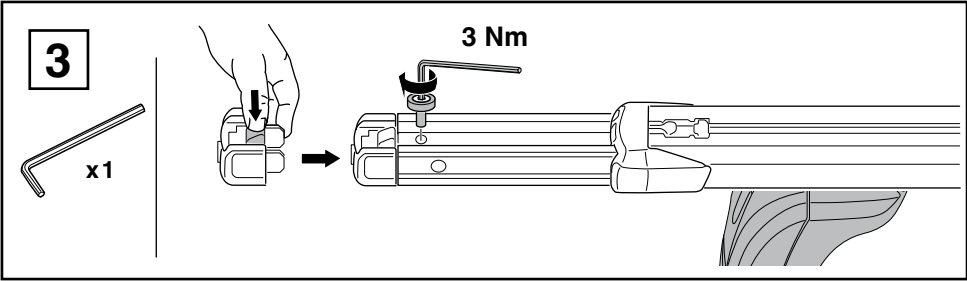



6

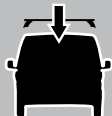

6

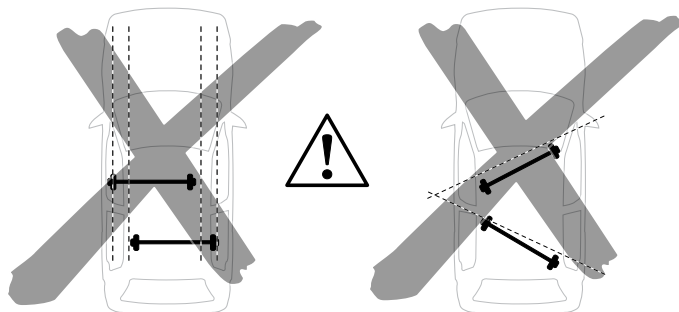
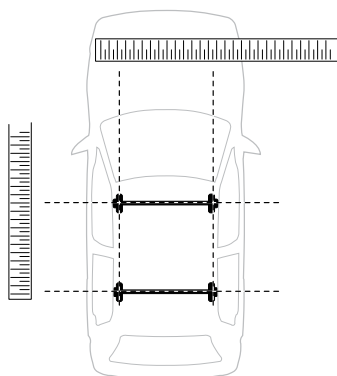
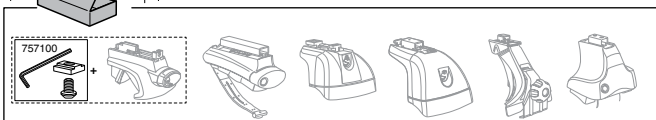
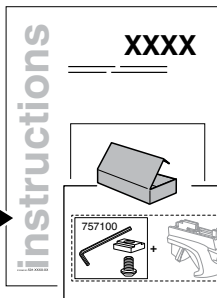
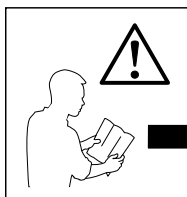



7 - 8

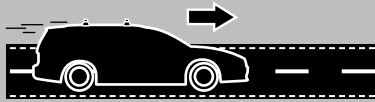

7

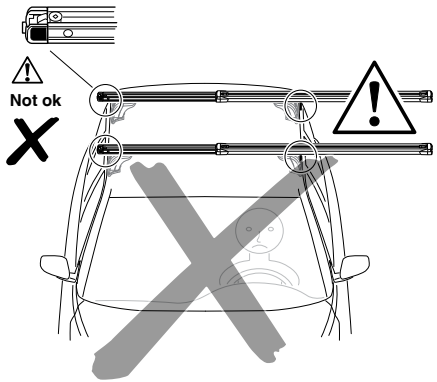
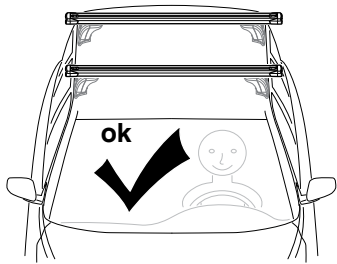
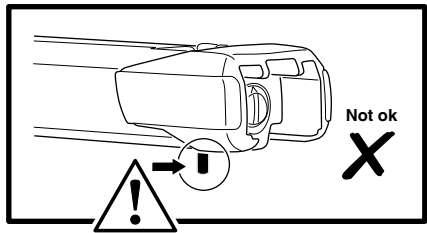
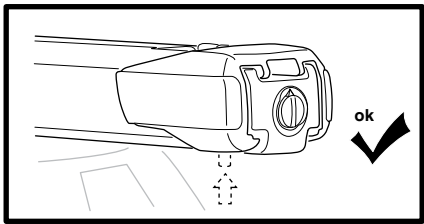

8

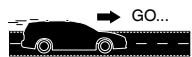
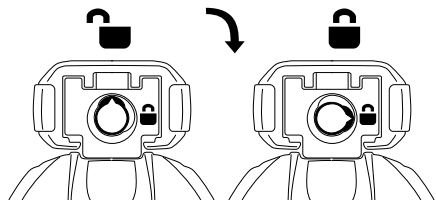
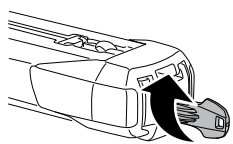

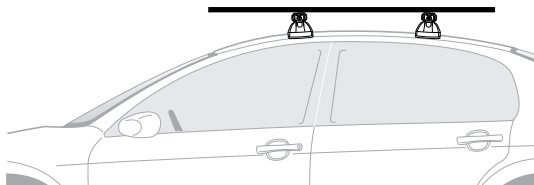

x2

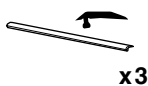
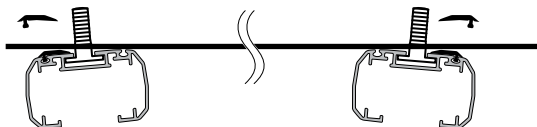

x3

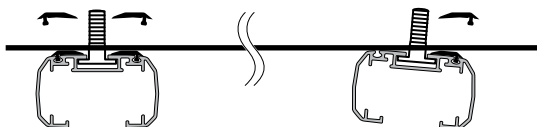

x3

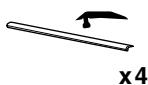
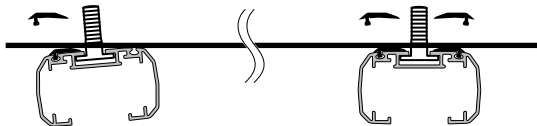

x4

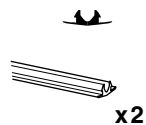
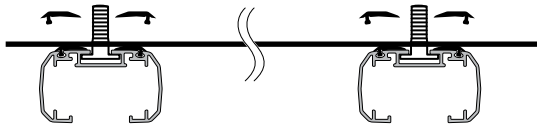

x2

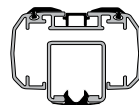
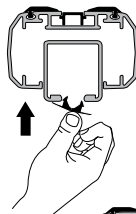
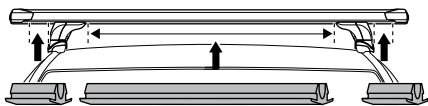
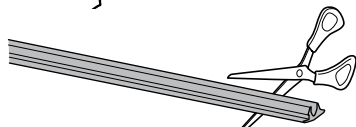



1 - 3



1

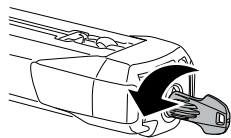

⚠ 100 %

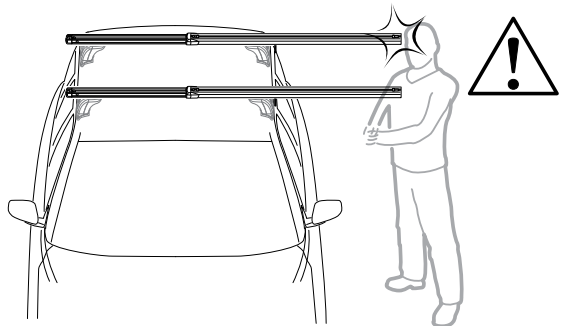
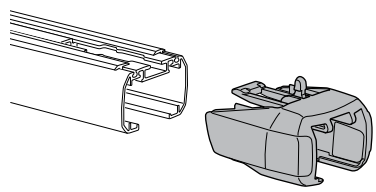
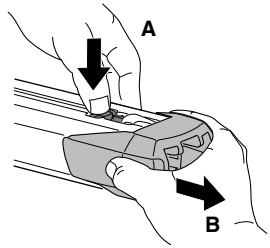
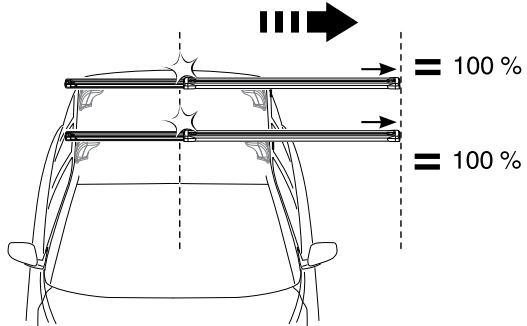
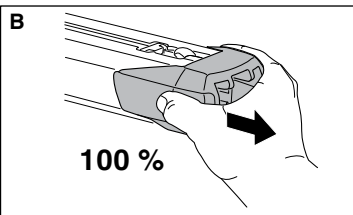
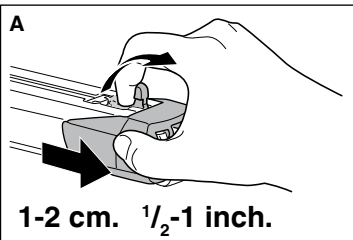

2

A

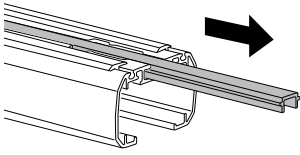

B

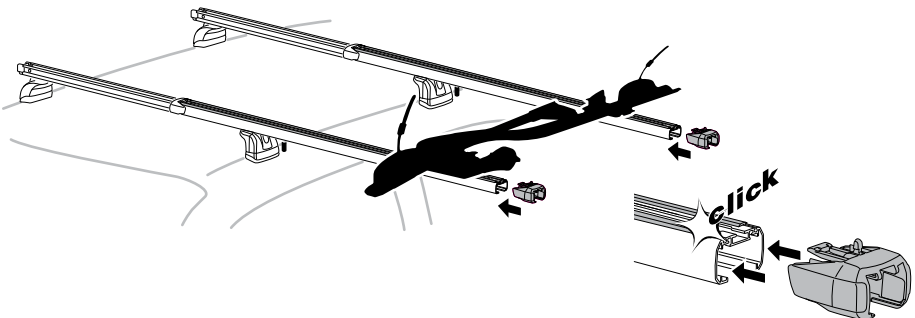
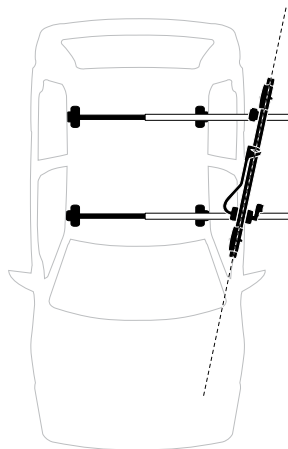
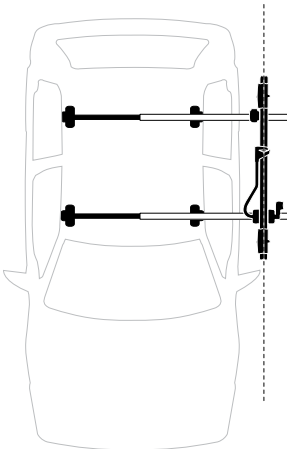
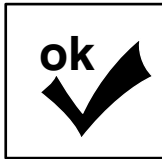
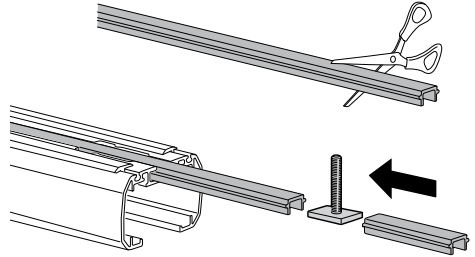

3

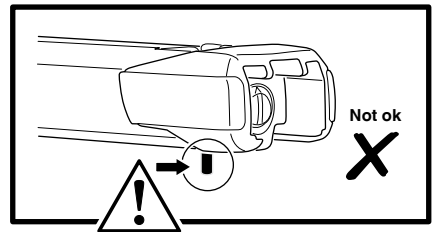
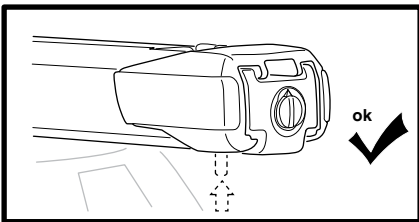
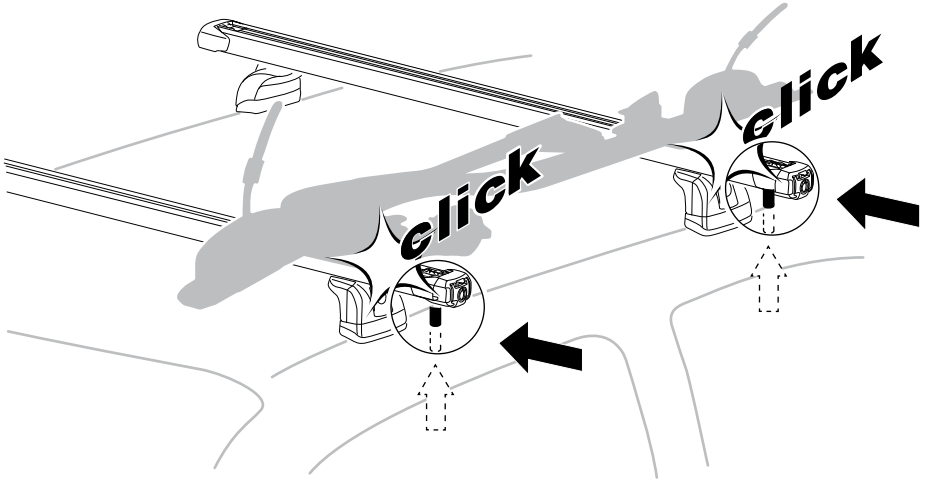
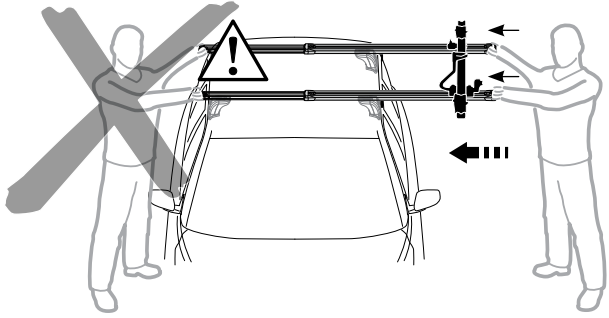
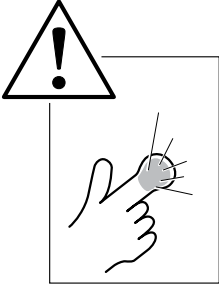

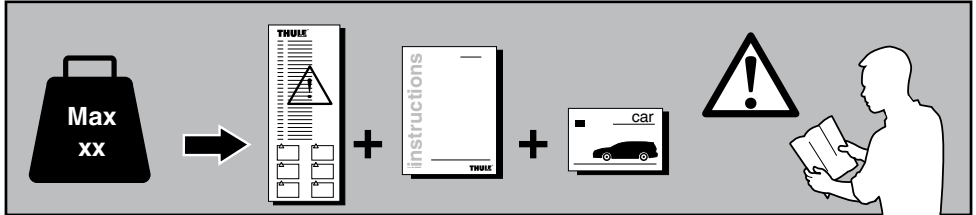
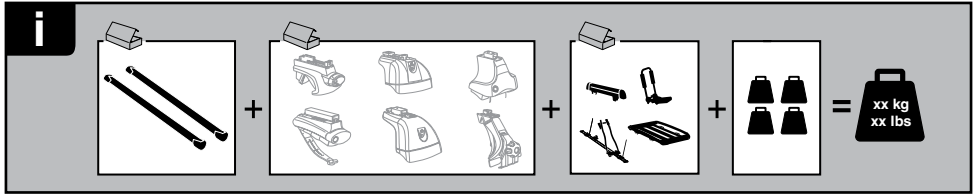

GB Maximum load Thule SlideBar = 90kg, or less if stated differently in roof rack- or car instruction manual.

D Maximale Last Thule Gleitschiene = 90kg, oder weniger, wenn im Handbuch für das Fahrzeug oder den Dachträger anders angegeben.

F Charge maximale de la barre coulissante Thule = 90 kg ou moins si ceci est mentionné sur le manuel d'utilisation de la barre de toit ou de la voiture.

NL Maximale belasting Thule SlideBar = 90kg, of minder indien anders aangegeven in de handleiding voor de imperiaal of de auto.

I Carico massimo per la barra scorrevole SlideBar Thule = 90 kg, o inferiore se previsto diversamente nel manuale del portapacchi o nel libretto di istruzioni del veicolo.

E Carga máxima de Thule SlideBar = 90 kg, o menos cuando aparezca otro valor en el portaequipajes de techo o en el manual de instrucciones del vehículo.

PT Carga máxima da Thule SlideBar = 90 kg ou menos se indicado outro valor no suporte de tejadilho ou no manual de instruções do automóvel.

S Maxlast Thule SlideBar = 90kg, eller lägre om så anges i lasthållarens eller bilens instruktionsbok.

FIN Suurin sallittu kuorma, Thule SlideBar = 90 kg tai vähemmän, jos kattotelineen tai auton käyttöoppaassa mainitaan toisin.

EST Talasüsteemi Thule SlideBar maksimaalne koormus on 90 kg või vähem, kui nii on katuseraami või auto kasutusjuhendis märgitud.

LAT Thule SlideBar maksimālā slodze = 90 kg vai mazāk, ja tā norādīts jumta bagāžnieka datos vai automobiļa lietošanas instrukcijā.

LIT Didžiausia „Thule SlideBar“ apkrova = 90 kg arba mažiau, jei stogo bagažinės arba automobilio instrukcijų vadove nurodyta kitaip.

PL Maksymalne obciążenie Thule SlideBar = 90kg lub mniej, jeśli w instrukcji obsługi auta lub bagażnika dachowego podana jest niższa wartość.

RU Максимальная грузоподъемность модели Thule SlideBar = 90 кг или меньше, если иное указано на модели багажника или в инструкции по эксплуатации автомобиля.

CZ Maximální zatížení nosiče Thule SlideBar = 90 kg nebo méně, je-li v příručce ke střešnímu nosiči nebo automobilu uvedeno jinak.

SK Maximálne zaťaženie nosiča Thule SlideBar = 90 kg alebo menej, ak je v príručke k strešnému nosiču alebo automobilu uvedené inak.

SLO Največja dovoljena obremenitev za Thule SlideBar je 90 kg ali manj, če je v navodilih za uporabo strešnih nosilcev ali vozila navedeno drugače.

HR Maksimalno opterećenje za Thule SlideBar = 90kg ili manje ako je drugačije navedeno na krovnom nosaču – ili u korisničkom vodiču automobila.

HU Thule SlideBar maximális teherbírása = 90 kg, vagy kevesebb, amennyiben a tetőtartó vagy az autó kezelési utasítása ennél kisebb értéket ír elő.

GR Μέγιστο φορτίο Thule SlideBar = 90kg, ή λιγότερο εάν αναφέρεται κάτι διαφορετικό στη σχάρα οροφής- ή στο εγχειρίδιο χρήσης αυτοκινήτου.

TR Thule Kilavuz Ray maksimum yük = 90 kg veya portbagaj ya da araba talimat kilavuzunda farklı belirtilmişse daha az.

日本語 Thule SlideBarの最大積載量は 90kg ですが、ルーフラックまたは車両の説明書では90kg 未満と記載されている場合があります。

中文 Thule 滑杆最大负载为 90kg, 如果车顶行李架或汽车说明手册中有其他说明则少于 90 kg。

한국어 루프 랙이나 차량 지침 설명서에 별도로 명시되어 있지 않은 한 Thule SlideBar의 최대 하중 = 90kg 이하

ไทย น้ำหนักบรรทุกสูงสุดสำหรับ Thule SlideBar = ไม่นเกิน 90 กก. หากระบุต่างจากนี้ในคู่มือการใช้งานโปรดติดต้นฉบับหลักฐานหรือคู่มือการใช้งานรถยนต์

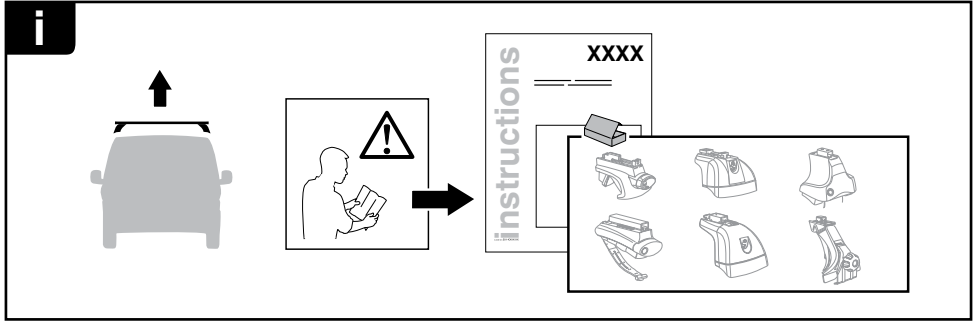

GB Accessories
D Zubehör
F Accessoires
NL Accessoires
I Accessori
E Accesorios
PT Acessórios

S Tillbehör
FIN Lisävarusteet
EST Lisavarustus
LAT Piederumi
LIT Priedai
PL Akcesoria
RU Аксессуары

CZ Doplnky
SK Príslušenstvo
SLO Dodatki
HR Dodaci
HU Tartozékok
GR Παρελκόμενα
TR Aksesuarlar

中文 附件
 日本語 付属品
 한국어 액세서리
 ไทย อุปกรณ์เสริม

