

Thule WingBar Edge 958X / 958XB

➤ Instructions

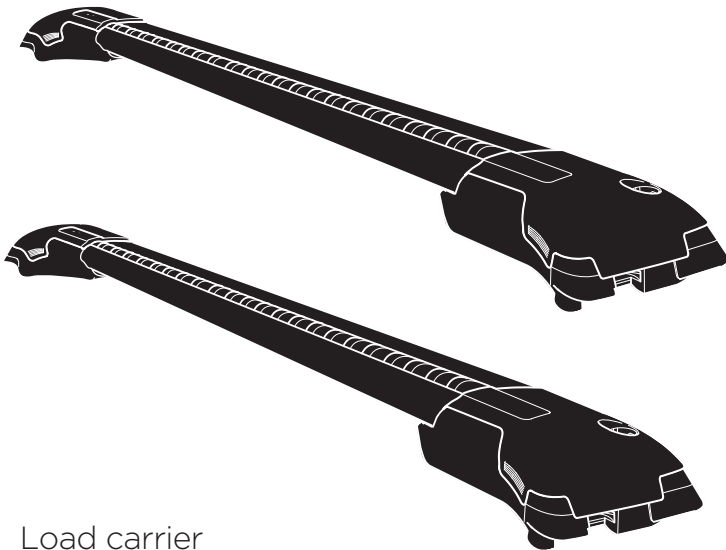

Load carrier



CITY CRASH
Complies with ISO norm

ISO 11154-E

958100, 958120, 958200, 958220, 958300, 958320, 958400, 958420, 958500, 958520

c.20150526

501-7700-04

Bring your life
thule.com

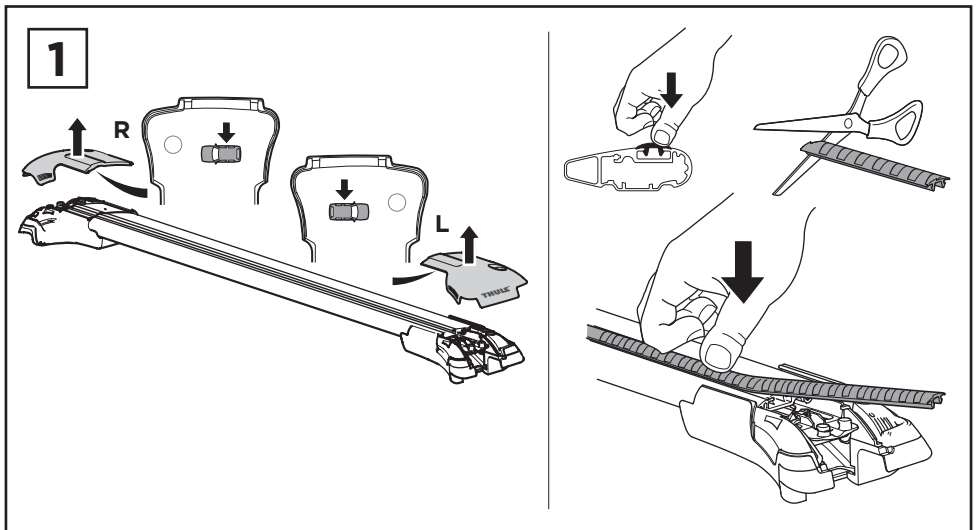
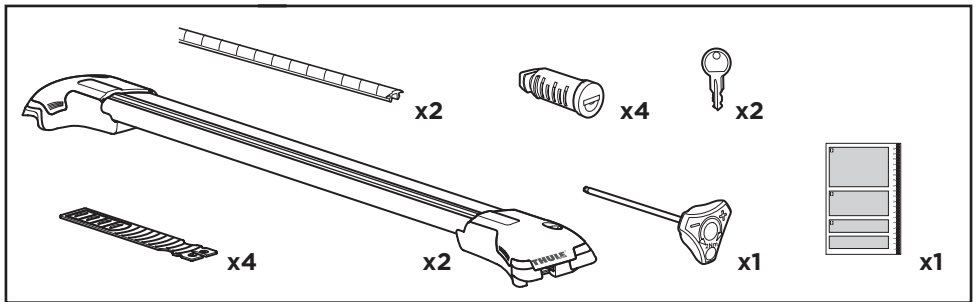
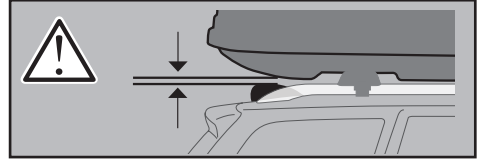
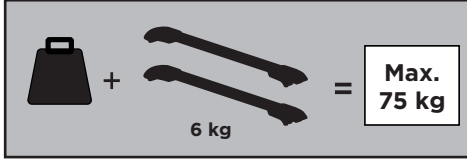
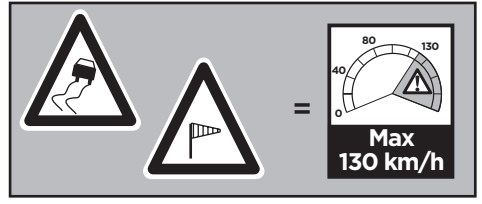
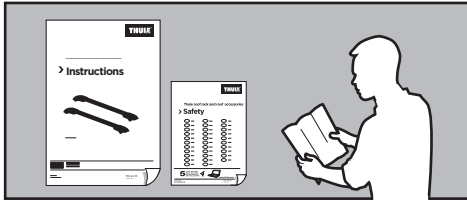

2

x1

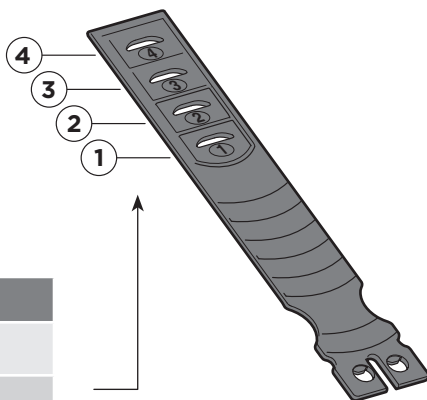
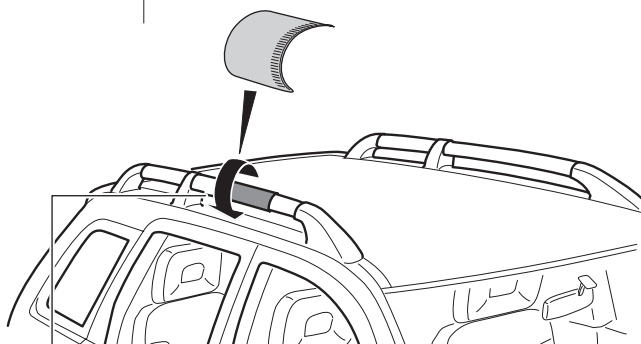
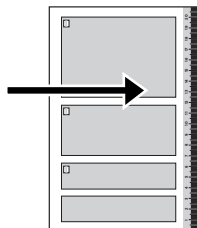
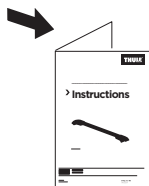

x1

i

Rail	Hole
163-192 mm	4
135-163 mm	3
107-135 mm	2
79-107 mm	1

3

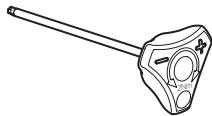

x1



x4

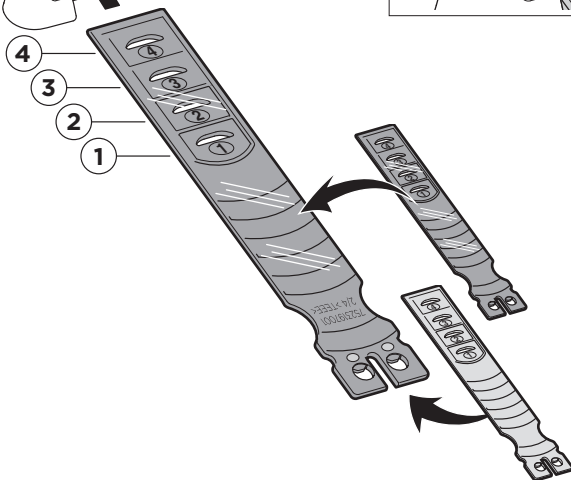
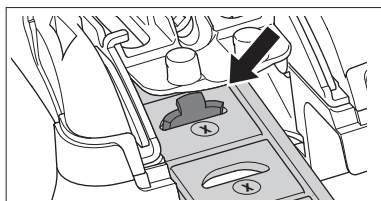
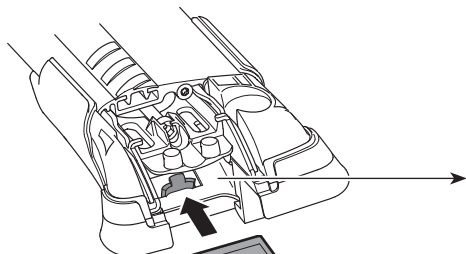
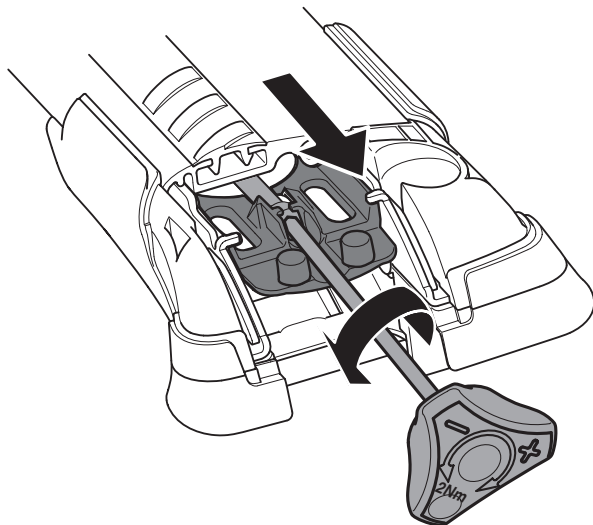

i

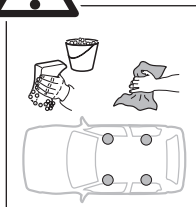
958100 / 958120
Wingbar Edge Rail S



958200 / 958220
Wingbar Edge Rail M

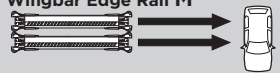

958300 / 958320
Wingbar Edge Rail L

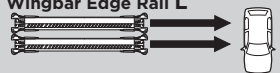

958400 / 958420
Wingbar Edge Rail S/M



958500 / 958520
Wingbar Edge Rail M/L



4

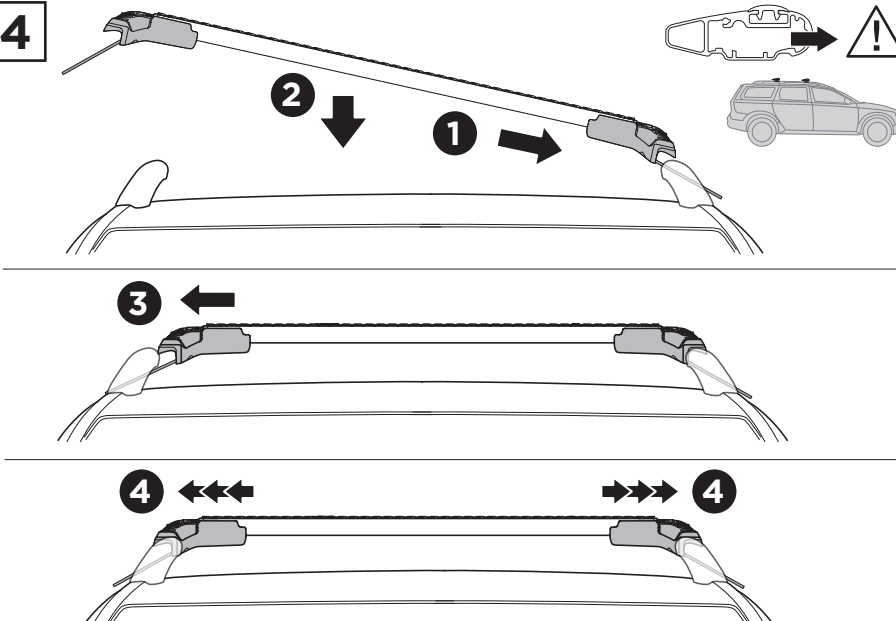

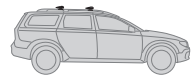

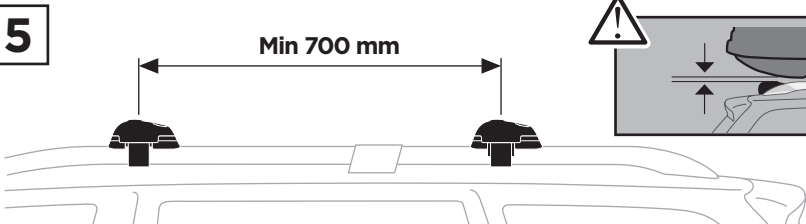

5

Min 700 mm

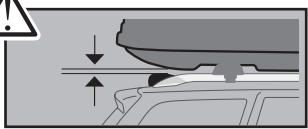

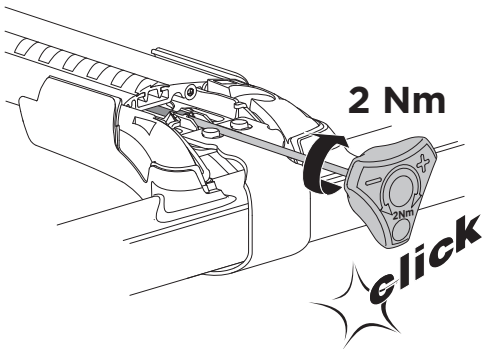
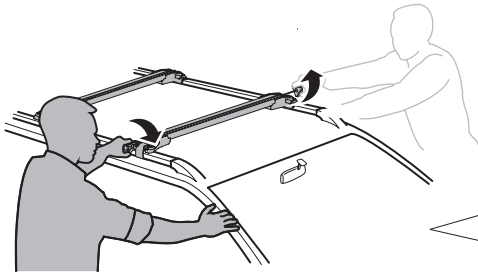
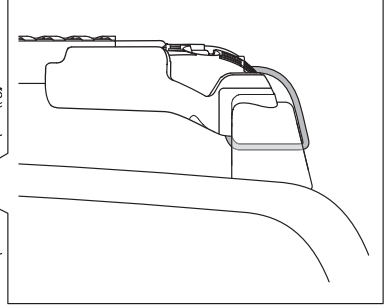
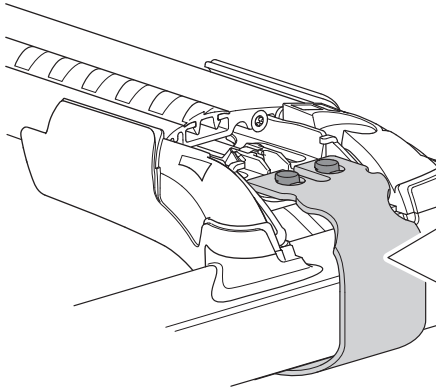
6

- EN** Tighten alternately
DE Die Schrauben abwechselnd anziehen
FR Serrer alternativement chaque côté
NL Afwisselend aan de linker- en de rechterkant aandraaien
IT Alternare il serraggio delle viti
ES Apretar alternativamente
PT Aperte alternadamente
SV Dra åt växelvis
DK Spænd skiftevis
NO Trekk til vekselvis
FI Kierrä vuorotellen
ET Pinguldage vaheldumisi
LV Pievelciēt pamīšus
LT Užsukinėkite pakaitomis
PL Śruby dokręcaj naprzemiennie
RU Затягивайте попеременно
UK Затягти по чергово
BG Затегнете последователно
CS Pokręťta багаžnika dokręcaj dokręcaj naprzemiennie.
SK Doťahujte striedavo
SL Privijajte izmenično
HR/BIH Naizmjenično zategnite
RO Strângeți alternativ
HU Egymástól függetlenül szorítandó
EL Σφιγίετε εναλλάξ
TR Dönüşümlü sıkın

إحكام الربط بالتناوب **AR**| חזק לסיווג **HE**

- ZH** 交替拧紧
JA 左右交互に締めつけてください
KO 번갈아 조이기
TH ชั่งนั้ແມ່ນສັ່ນ

7



x2



x4

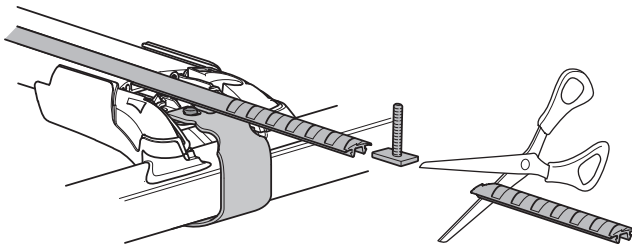
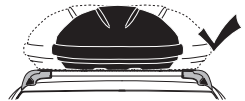
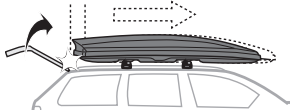
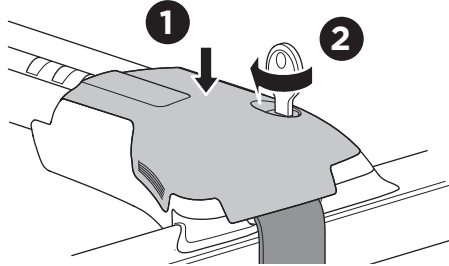
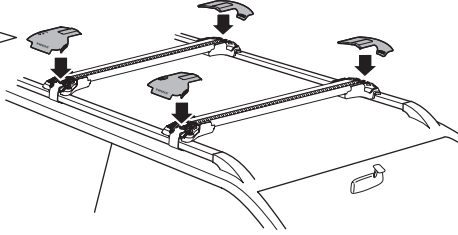
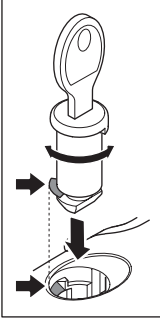
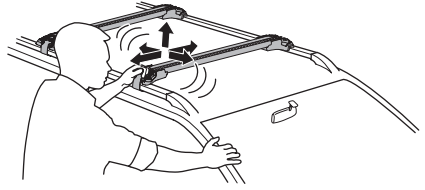

20
19
18
17
16
15
14
13
12
11
10
9
8
7
6
5
4
3
2
1

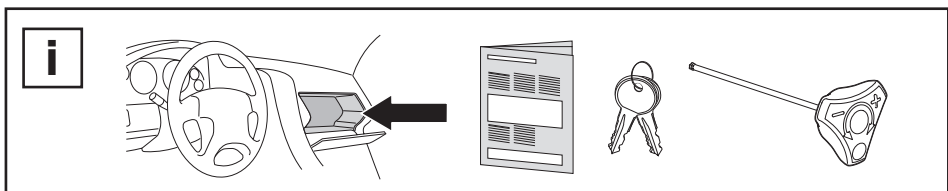
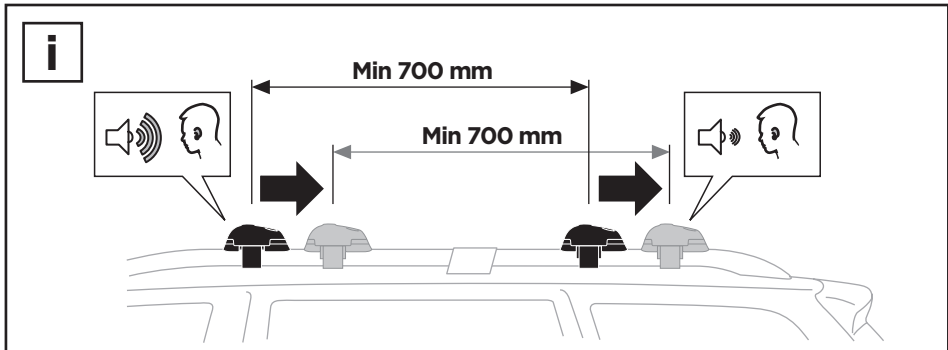
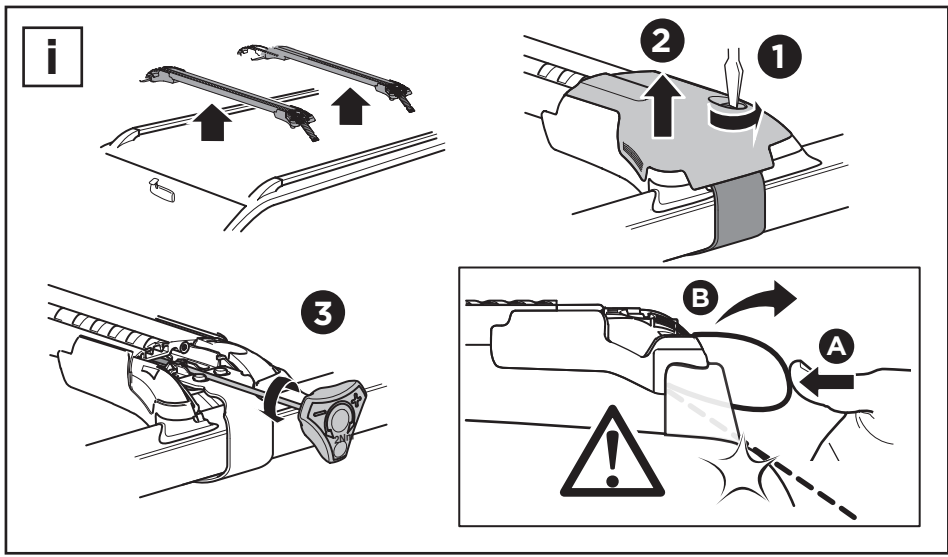

Thule One-Key System

- 544 (x4)
- 596 (x6)
- 588 (x8)
- 452 (x12)